



Installation instructions, accessories

Volvo Car Corporation Gothenburg, Sweden

Instruction No	Version	Part. No.
31339384	1.0	31339328

Net pocket, kit



Installation instructions, accessories

Volvo Car Corporation Gothenburg, Sweden

Equipment

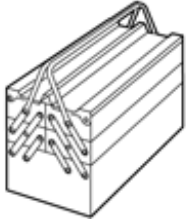

IMG-345497



IMG-239660

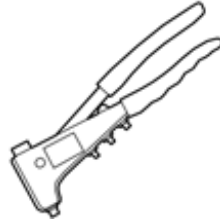

IMG-239940



IMG-239981

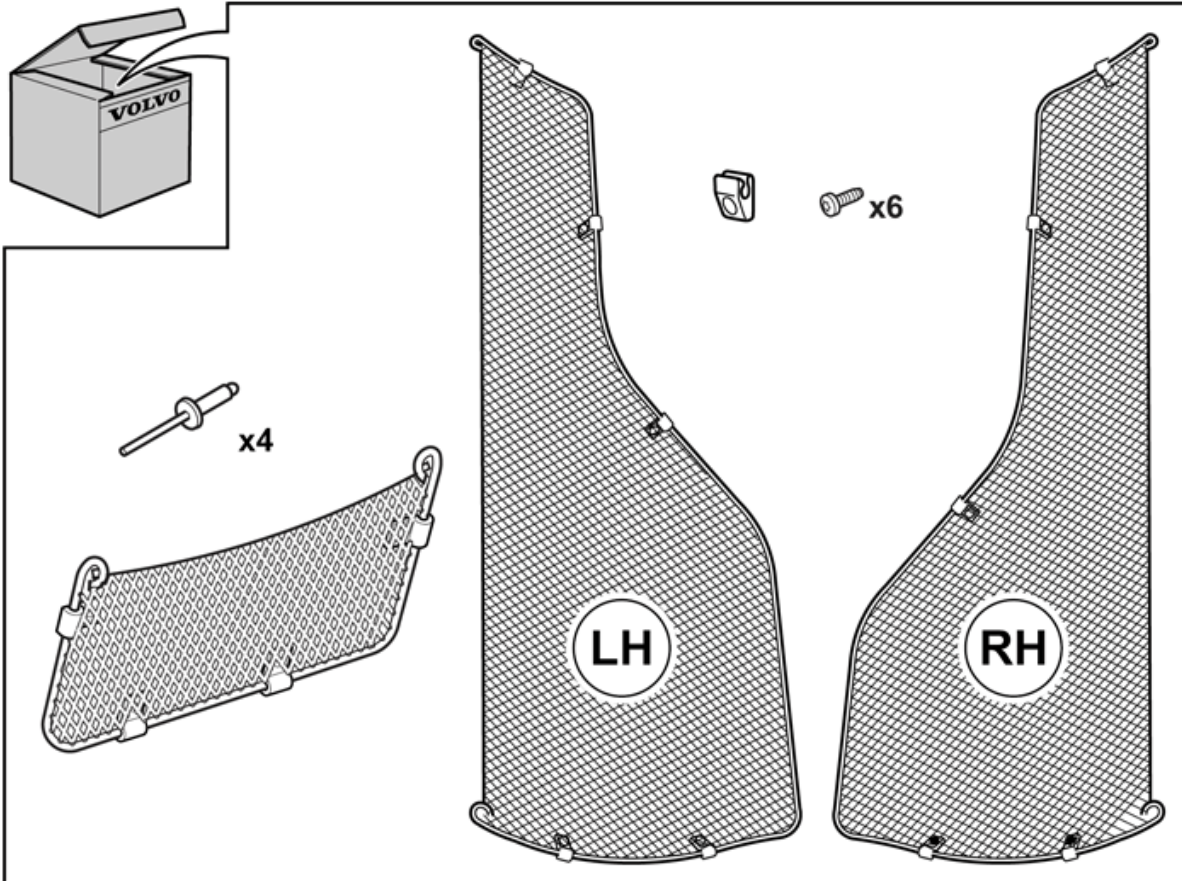

IMG-352754



Installation instructions, accessories

Volvo Car Corporation Gothenburg, Sweden

INTRODUCTION

Read through all of the instructions before starting installation.

Notifications and warning texts are for your safety and to minimise the risk of something breaking during installation.

Ensure that all tools stated in the instructions are available before starting installation.

Certain steps in the instructions are only presented in the form of images. Explanatory text is also given for more complicated steps.

In the event of any problems with the instructions or the accessory, contact your local Volvo dealer.

Note!

Some steps in these installation instructions are presented with illustration only.

Net pocket, cargo compartment, side panel

Net pocket, cargo compartment, side panel

Attach a piece of tape edge-to-edge with the panel for the rear load securing eyelet as illustrated. Measure and mark out for drilling holes for the lower rear clip.

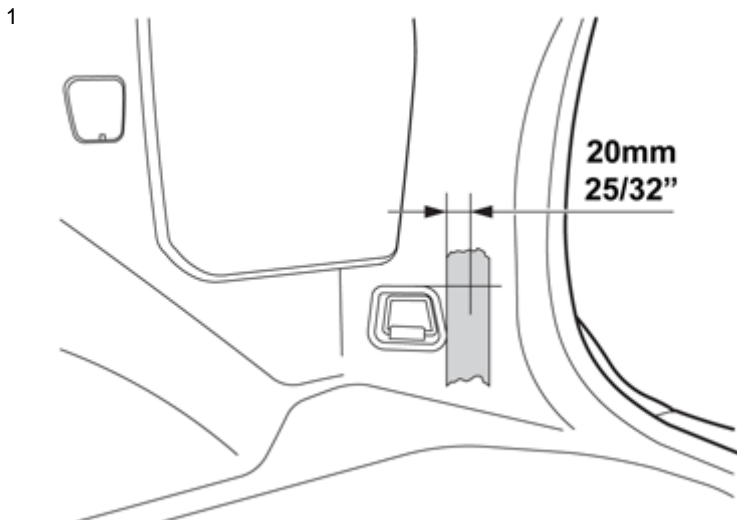

IMG-285745



Installation instructions, accessories

Volvo Car Corporation Gothenburg, Sweden

2

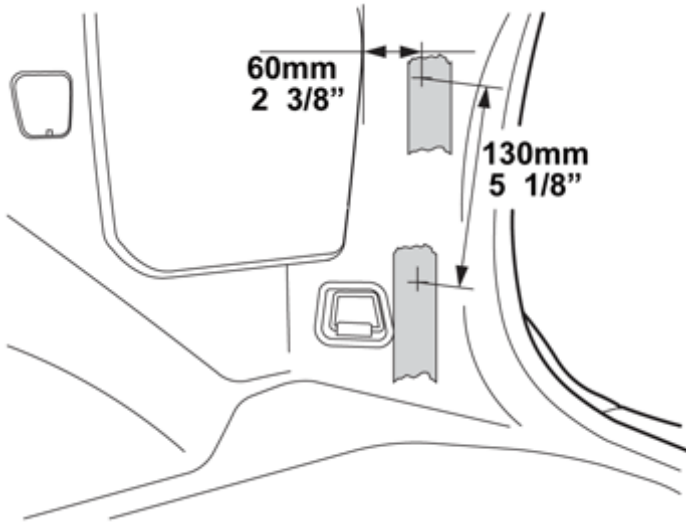

IMG-285746

Attach a piece of tape on top of the previous one as illustrated. Measure for drilling the upper hole in the clip.

3

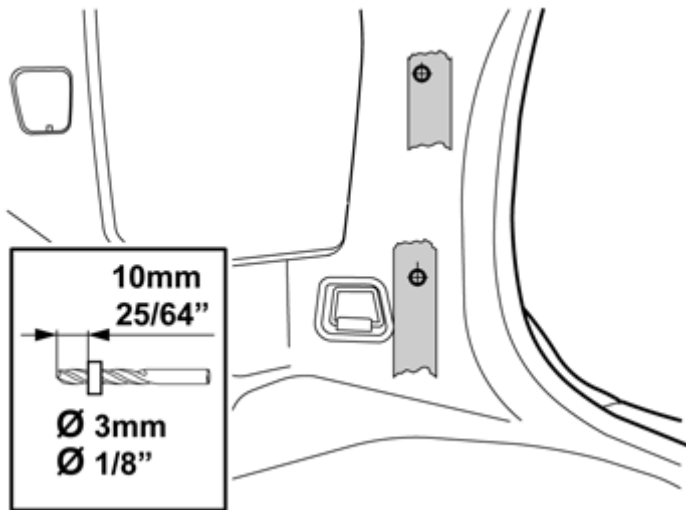

IMG-293163

Drill two $\text{Ø}3$ mm ($1/8$ ") holes through the panel. Use a 10 mm ($25/64$ ") drill stop.

Remove the pieces of tape and swarf.

4

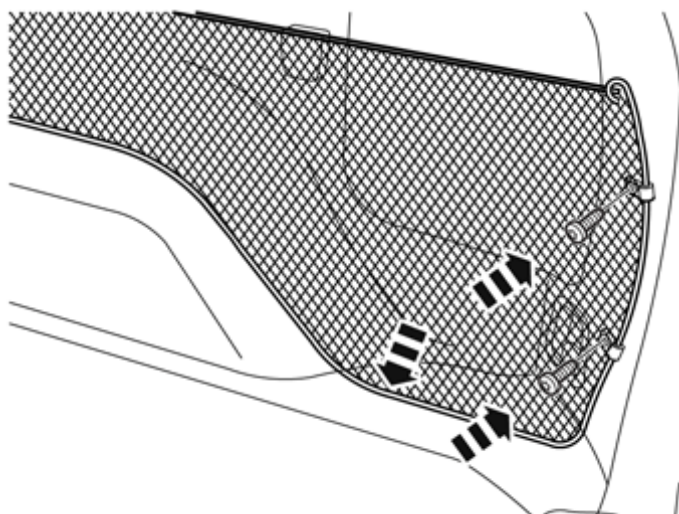

IMG-293164

Take screws and the mesh from the kit. Tighten the screws at the rear edge of the mesh pocket, with the mesh pocket positioned towards the lower edge of the side panel.



Installation instructions, accessories

Volvo Car Corporation Gothenburg, Sweden

5

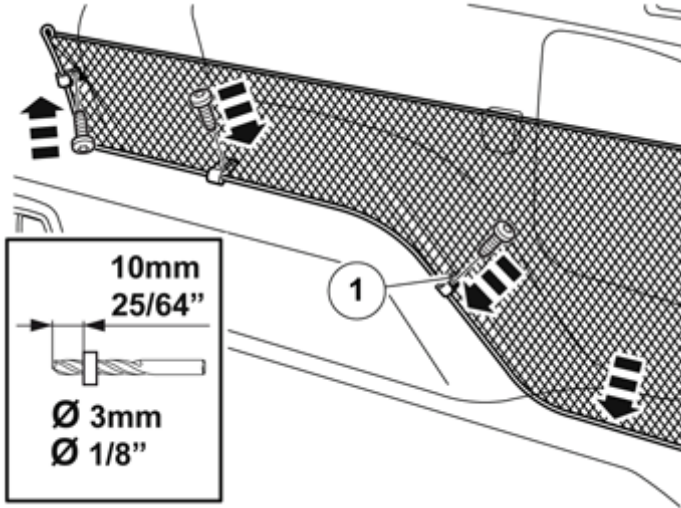

IMG-293165

Fold the mesh pocket towards the side panel and ensure that it is against it at the arrow markings.

Drill a $\text{\O}3$ mm ($1/8$ ") hole through the clips and panel at clip (1). Use a 10 mm ($25/64$ ") drill stop.

Remove any swarf.

Take the screw and tighten the clip.

Ensure that the mesh pocket is flush at the two front arrow markings. Repeat drilling and tightening as above.

6

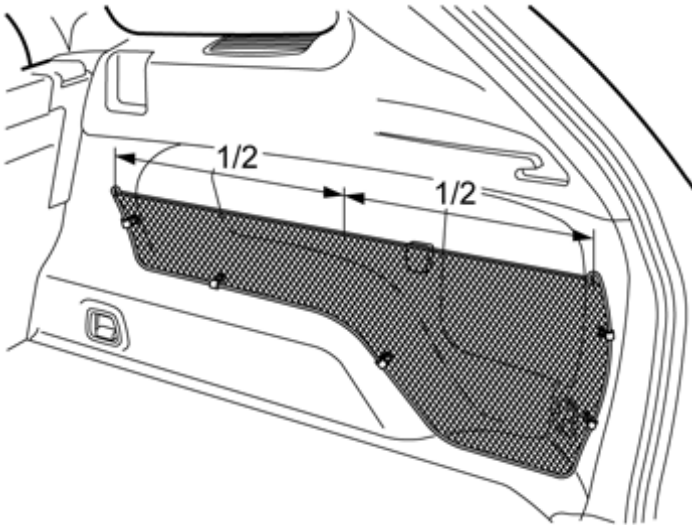

IMG-304823

Measure out half the distance between the net pocket's eyelets and make a mark on the side panel, about the same height as the two eyelets.

7

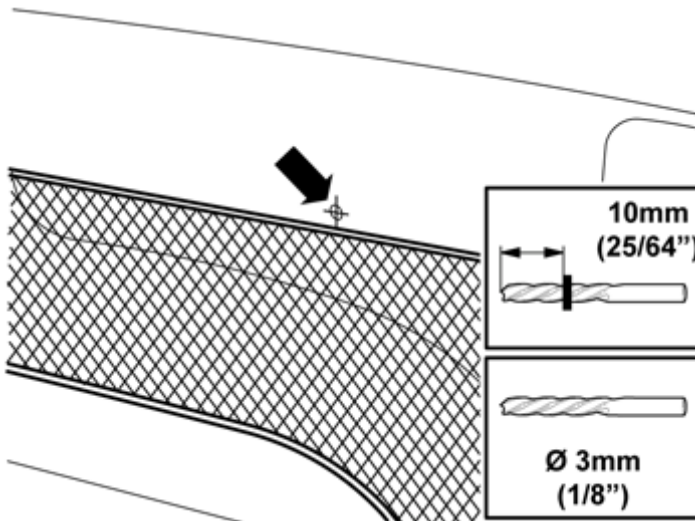

IMG-304824

Drill the hole in the panel. Use drill stop.

Remove any swarf.



Installation instructions, accessories

Volvo Car Corporation Gothenburg, Sweden

8

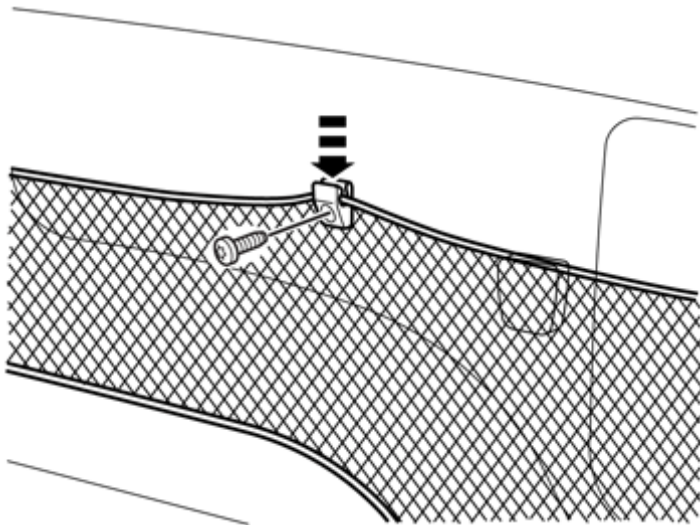

IMG-304825

Get clips and screws from the kit and tighten down.

Press on the net pocket's longitudinal rubber band in the clip.

Repeat the steps for installation on the opposite side.

Net pocket, tunnel console

9

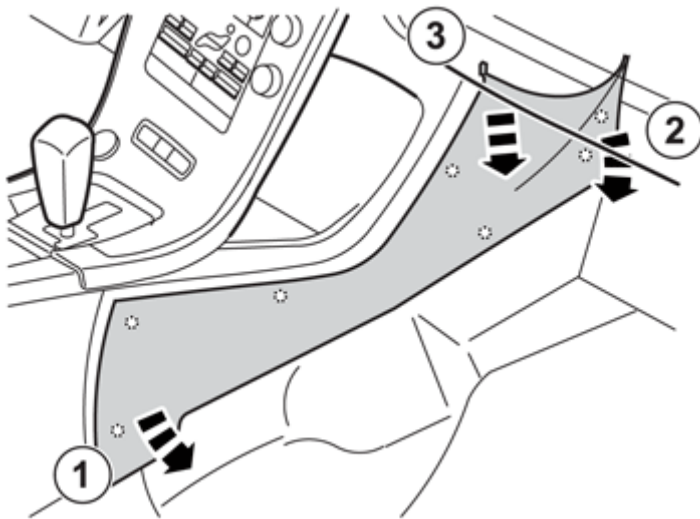

IMG-282528

Net pocket, tunnel console

Remove the tunnel console's right-hand side panel by carefully pulling it away. Start at the front edge. The side panel is secured with five clips on the inside.



Installation instructions, accessories

Volvo Car Corporation Gothenburg, Sweden

10

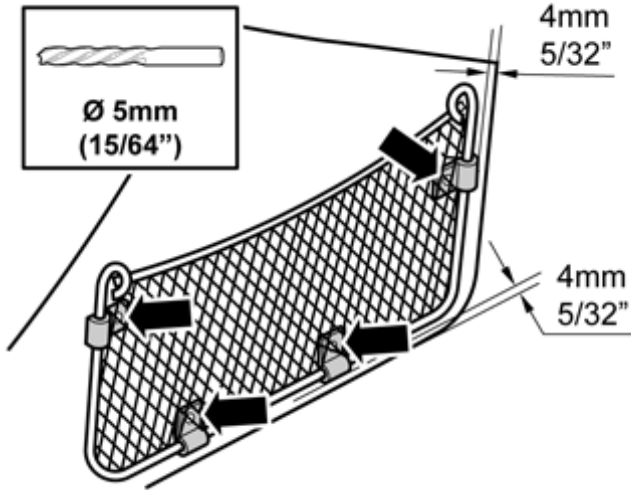

IMG-292243

Place the mesh pocket on the panel with the front edge of the clips 4 mm (5/32") from the panel's front and rear edge. Attach the mesh pocket using tape to secure it.

Note!

Take care not to damage the pocket lugs.

Drill holes through the clips and through the panel. Use a Ø5 mm (13/64") drill bit.

File down the edges of the holes.

11

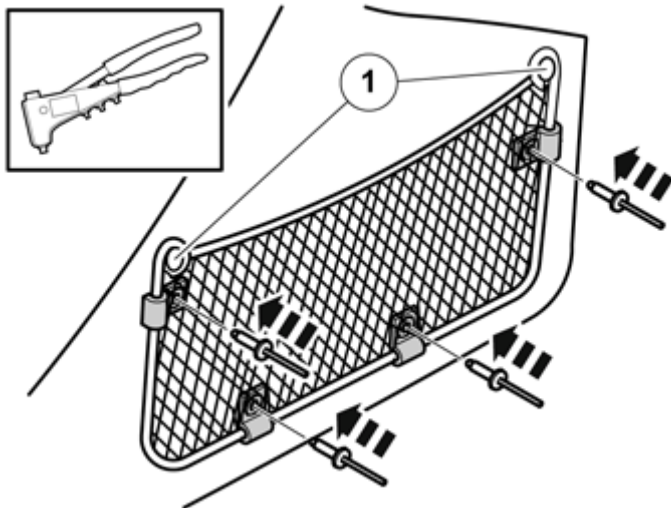

IMG-292244

Position the mesh pocket with the clips against the holes in the side panel and with the pocket's buttons (1) pointing outwards.

Rivet the clips with the mesh pocket to the panel.

Note!

Ensure that the pocket is not trapped by the rivet heads.

12

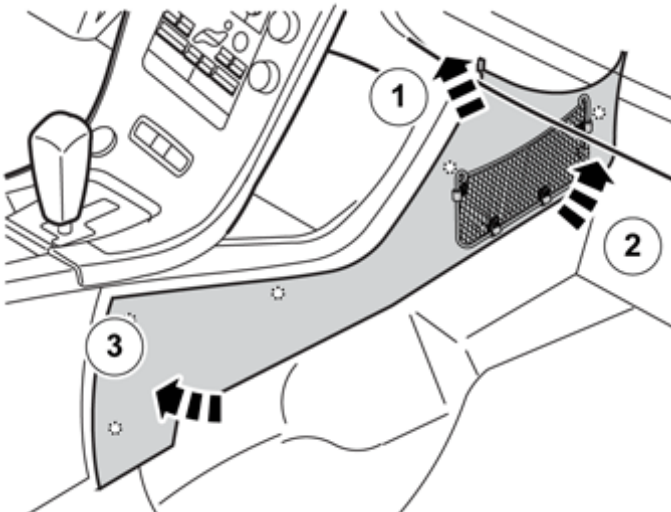

IMG-285736



Installation instructions, accessories

Volvo Car Corporation Gothenburg, Sweden
